

Hierarchical Bayes 2

Hierarchical Models

- Model variability in the parameters of a model
- Partition variability more explicitly into multiple terms
- Borrow strength across data sets
- Details usually in the SUBSCRIPTS
- Hierarchical with respect to parameters

Hierarchical Mean

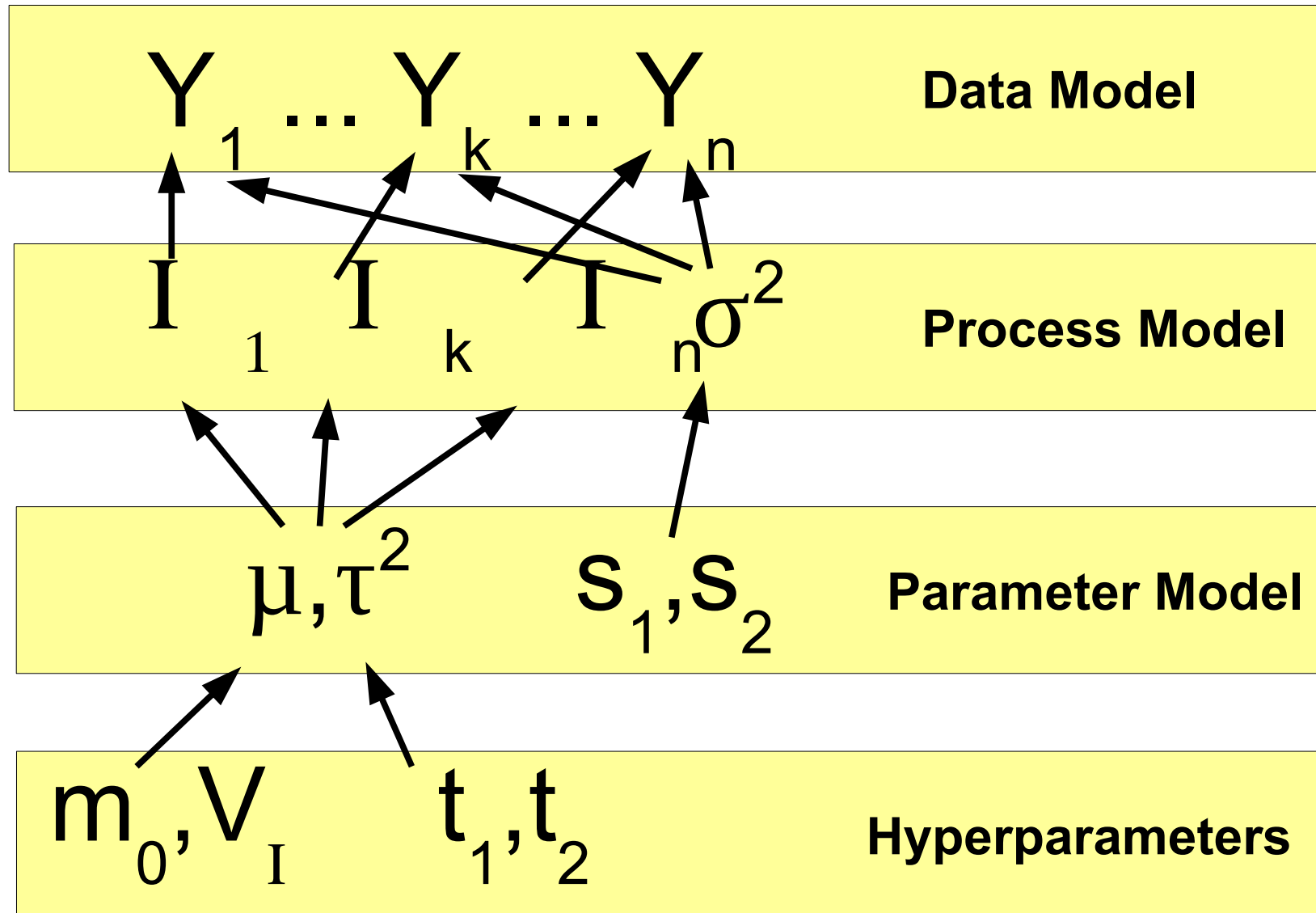

Random Effects Linear Model

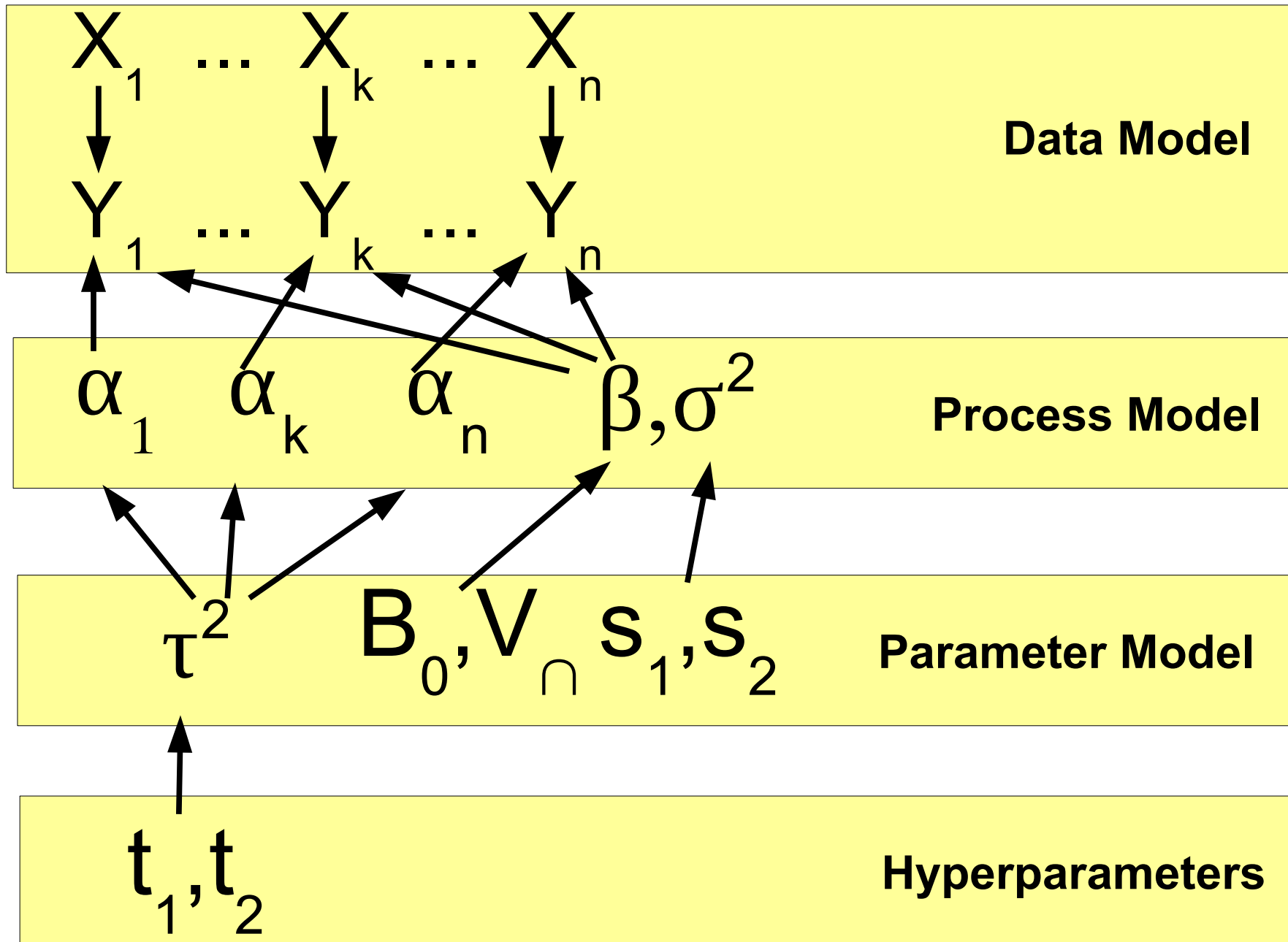

Why bother?

Impacts on inference...

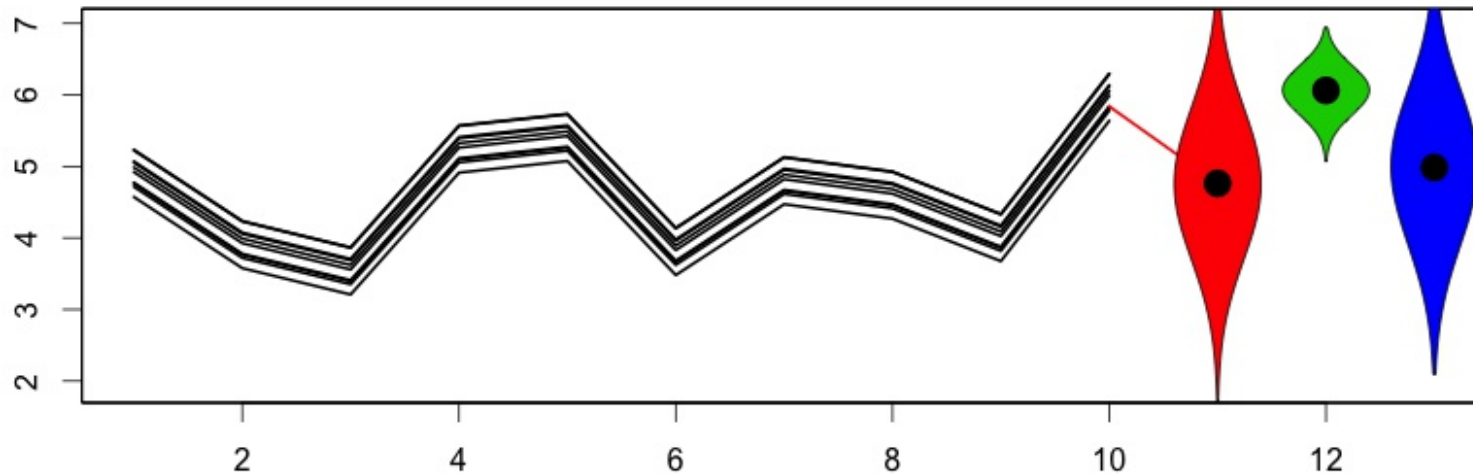
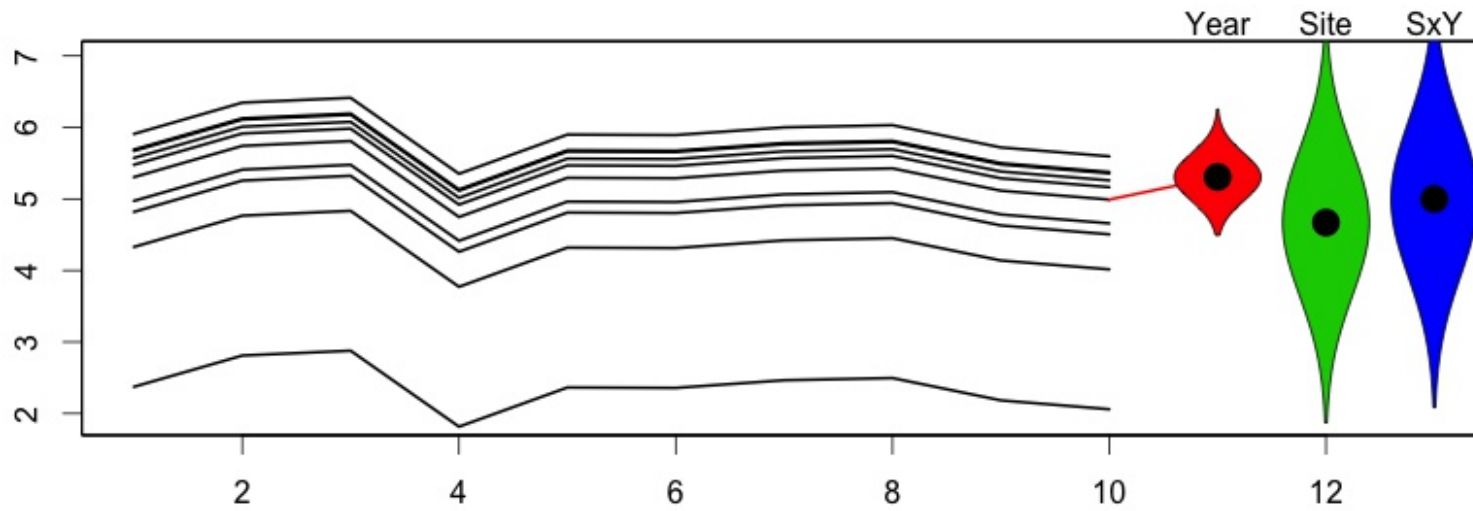

Start Simple

Progressively
Add Complexity

Example: Tree Allometries

- 53 spp
- 1691 obs
- Mixed temperate
- North Carolina

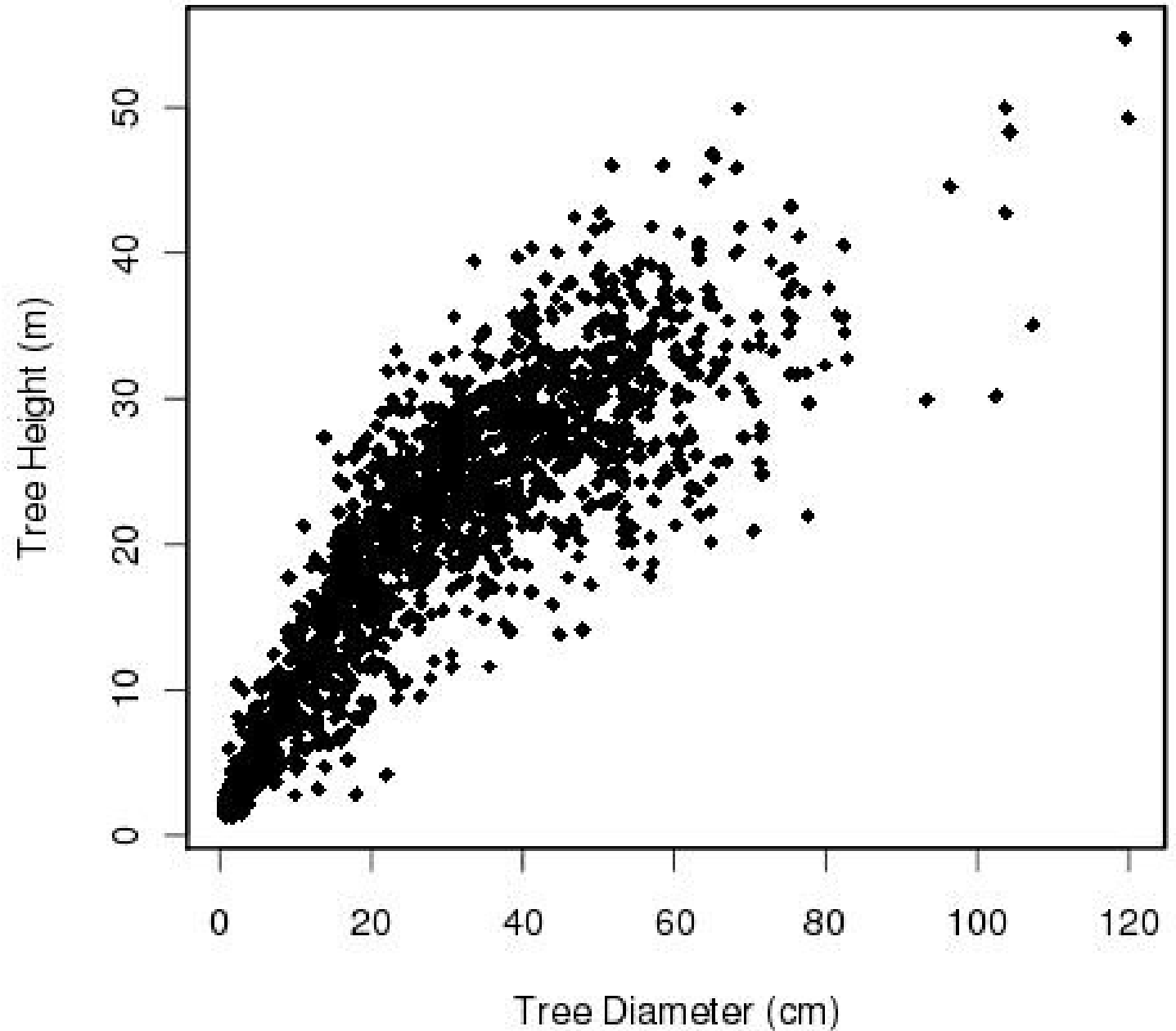



Contents lists available at [ScienceDirect](#)

Forest Ecology and Management

journal homepage: www.elsevier.com/locate/foreco

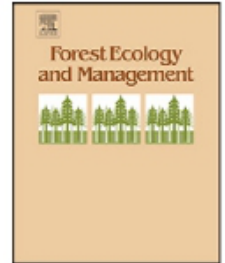

Capturing diversity and interspecific variability in allometries: A hierarchical approach

Michael C. Dietze^{1,*}, Michael S. Wolosin, James S. Clark

Nicholas School of the Environment and Department of Biology, Duke University, Durham, NC 27708, USA

ARTICLE INFO

Article history:

Received 28 November 2007

Received in revised form 4 July 2008

Accepted 17 July 2008

Keywords:

Allometry

Crown radius

Hierarchical Bayes

DBH

Propagating uncertainty

Crown shape

ABSTRACT

There is growing recognition of the role of mechanistic scaling laws in shaping ecological pattern and process. While such theoretical relationships explain much of the variation across large scales, at any particular scale there is important residual variation that is left unexplained among species, among individuals within a species, and within individuals themselves. Key questions remain on what explains this variability and how we can apply this information in practice, in particular to produce estimates in high-diversity systems with many rare and under-sampled species. We apply hierarchical Bayes statistical techniques to data on crown geometry from diverse temperate forests in order to simultaneously model the differences within and among species. We find that tree height, canopy depth, and canopy radius are affected by both successional stage and wood mechanical strength, while tree height conforms to the predicted $2/3$ power relationship. Furthermore, we show that hierarchical modeling allows us to constrain the allometries of rare species much more than traditional methods. Finally, crown radius was shown to vary substantially more within individuals than among individuals or species, suggesting that the capacity for local light foraging and crown plasticity exerts the dominant control on tree crowns.

Motivation

- Allometric relationships commonly fit for both theoretical (scaling law) and practical (prediction) purposes
- Biomass allometries critical to terrestrial carbon budget
- Very difficult to fit site and species specific relationships in high diversity forests
- Often resort to “global” allometries
 - Introduce bias, not averaged out w/ lg sample
- Little attention to causes of variability across species

Process Model

- Power law

$$Y = aX^b$$

$$\log(Y) = \beta_0 + \beta_1 \log(X)$$

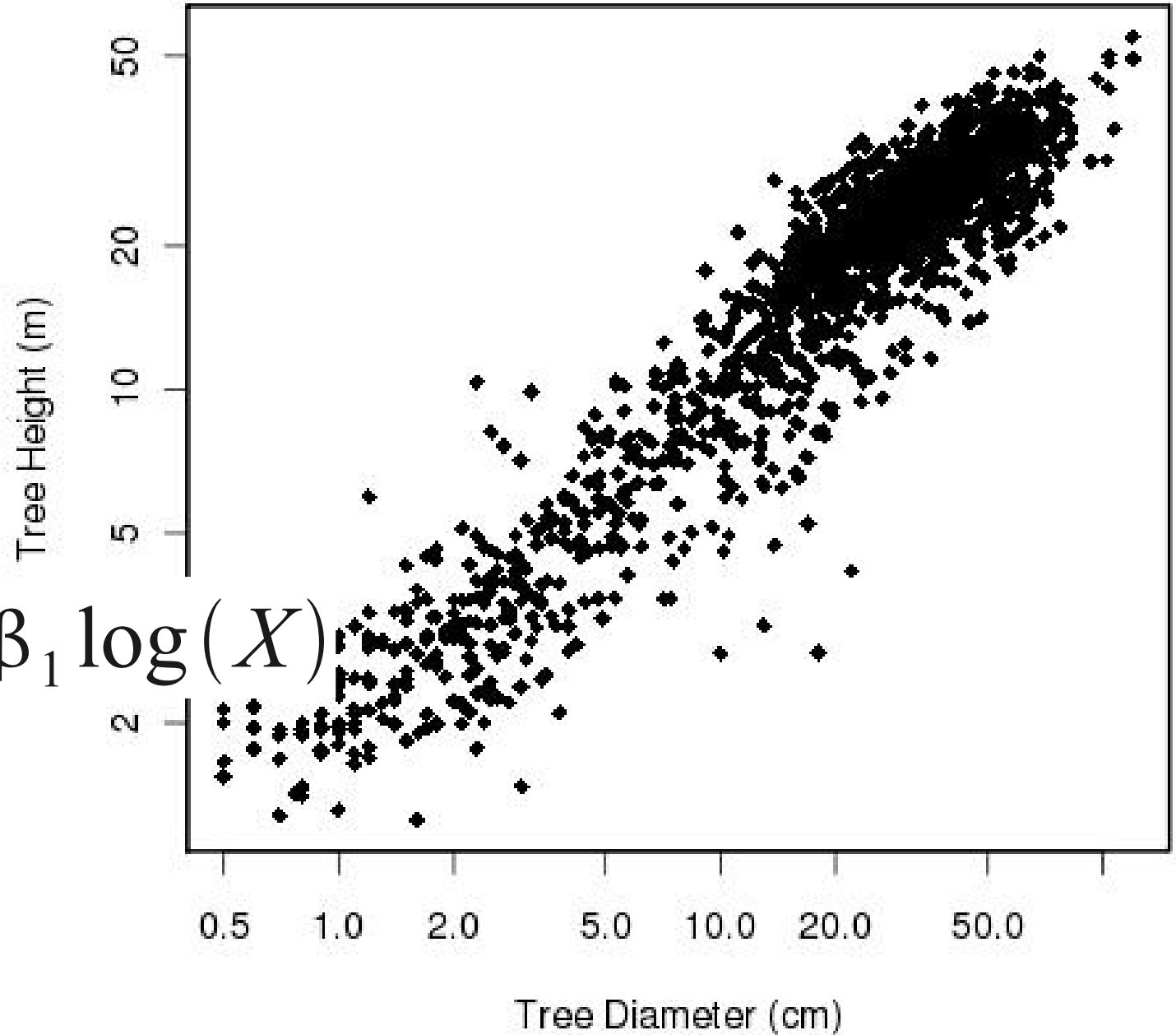

Samples per Species

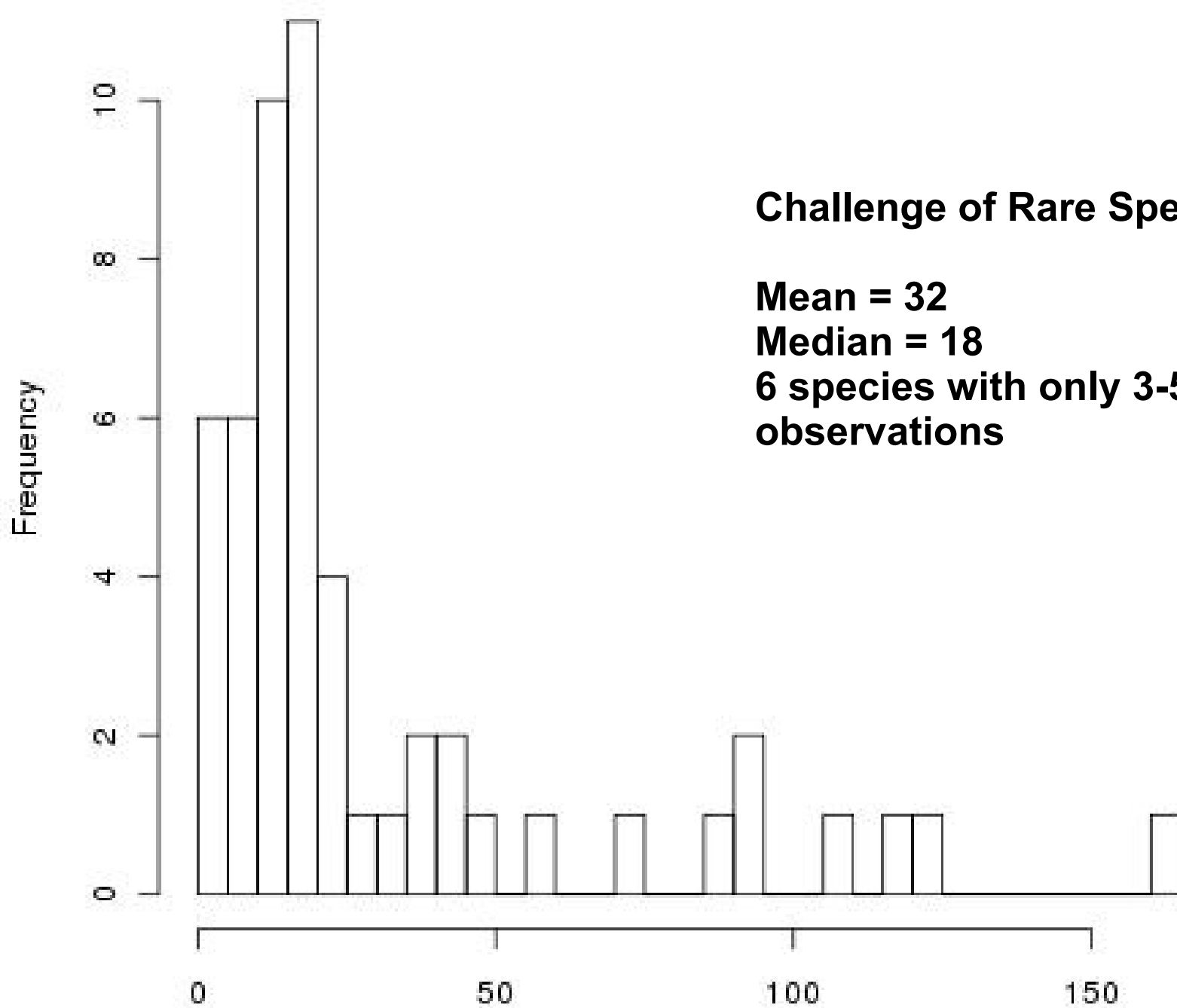

Hierarchical Model

- Based both on theory and observation, the allometric relationships across species are very similar
- Treat the regression parameters as coming from a common process, but with “random” species to species variability

Hierarchical Linear Model

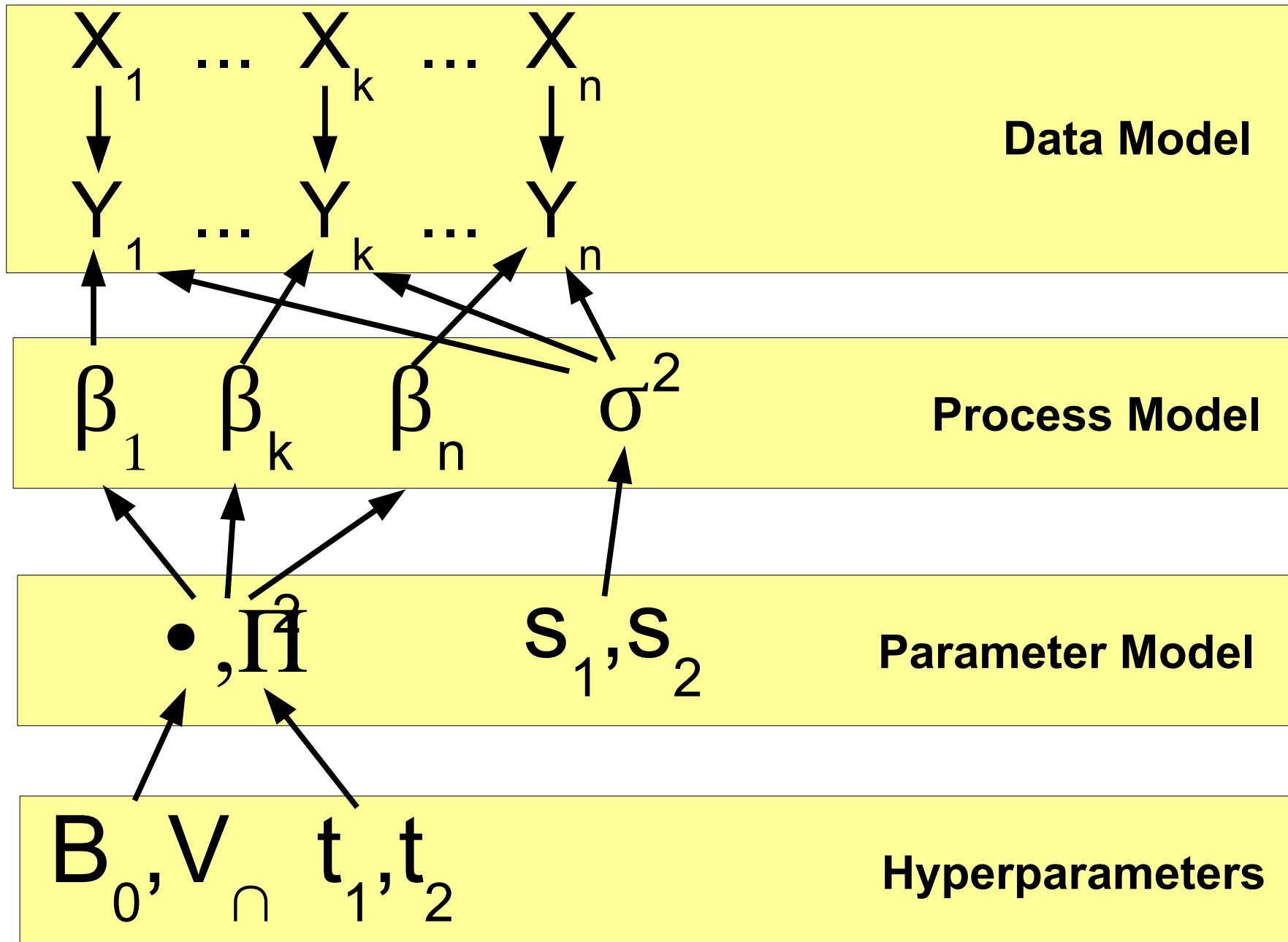

$$H_{i,k} = \log_{10}(\textit{Height}_{i,k})$$

$$D_{i,k} = \log_{10}(\textit{DBH}_{i,k})$$

$$H_{i,k} \sim N(\beta_{0,k} + \beta_{1,k} D_{i,k}, \sigma^2)$$

$$\beta_k \sim N_2(B, \tau^2 I)$$

$$\sigma^2 \sim IG(s_1, s_2)$$

$$B \sim N_2(B_0, V_B)$$

$$\tau_j^2 \sim IG(t_1, t_2)$$

$$\beta_k \sim \prod N(H_{i,k} | \beta_{0,k} + \beta_{1,k} D_{i,k}, \sigma^2) \\ \times N_2(\beta_k | B, \tau^2 I)$$

$$\sigma^2 \sim \prod N(H_{i,k} | \beta_{0,k} + \beta_{1,k} D_{i,k}, \sigma^2) \\ \times IG(\sigma^2 | s_1, s_2)$$

$$B \sim \prod N_2(\beta_k | B, \tau^2 I) N_2(B | B_0, V_B)$$

$$\tau_j^2 \sim \prod N(\beta_{j,k} | B, \tau_j^2) IG(\tau_j^2 | t_1, t_2)$$

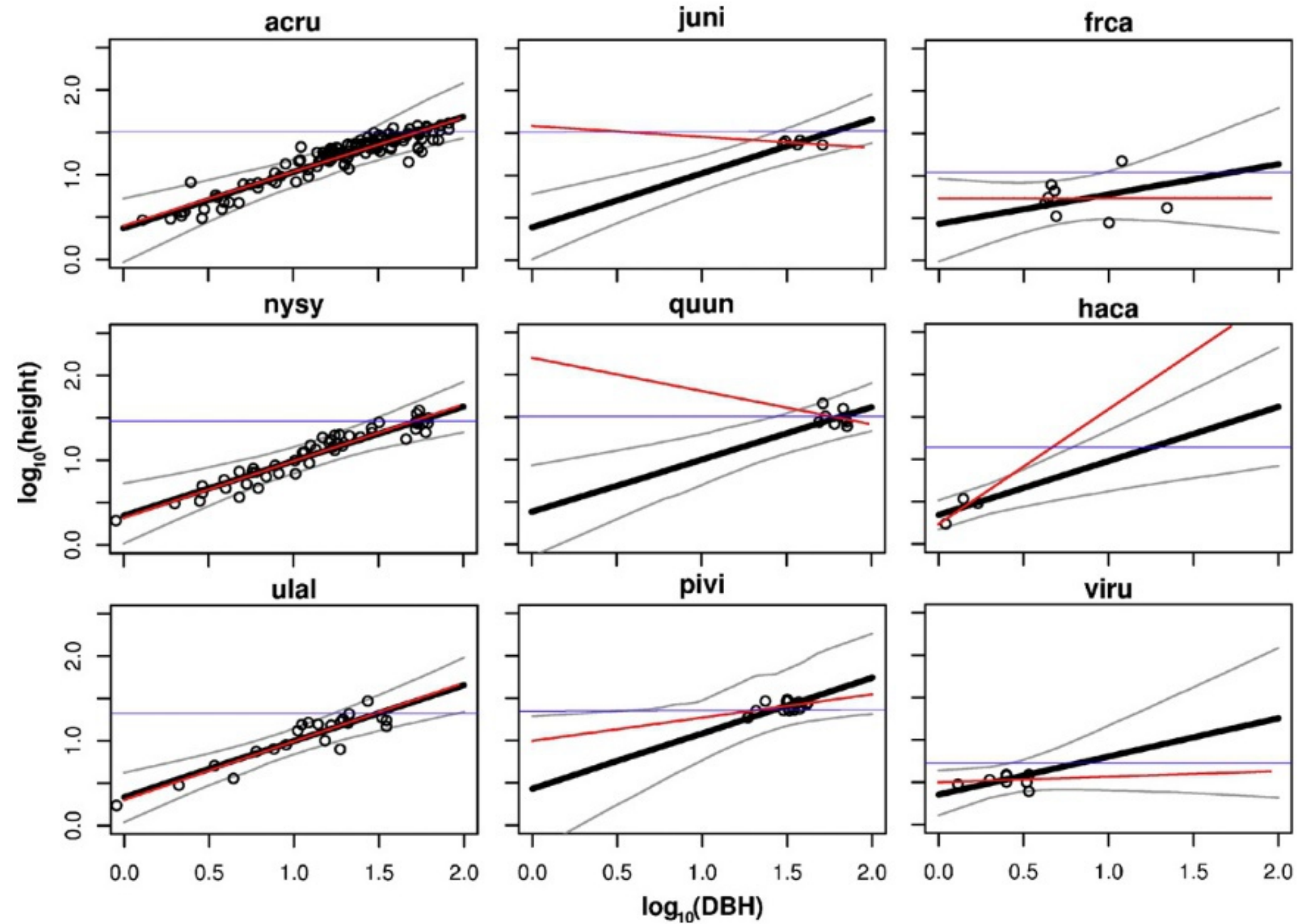

- Model extended to multivariate case
 $Y = [H, \theta, R]$
- Fit three response variables simultaneously
- Assess hierarchical *covariance* between the three response variables

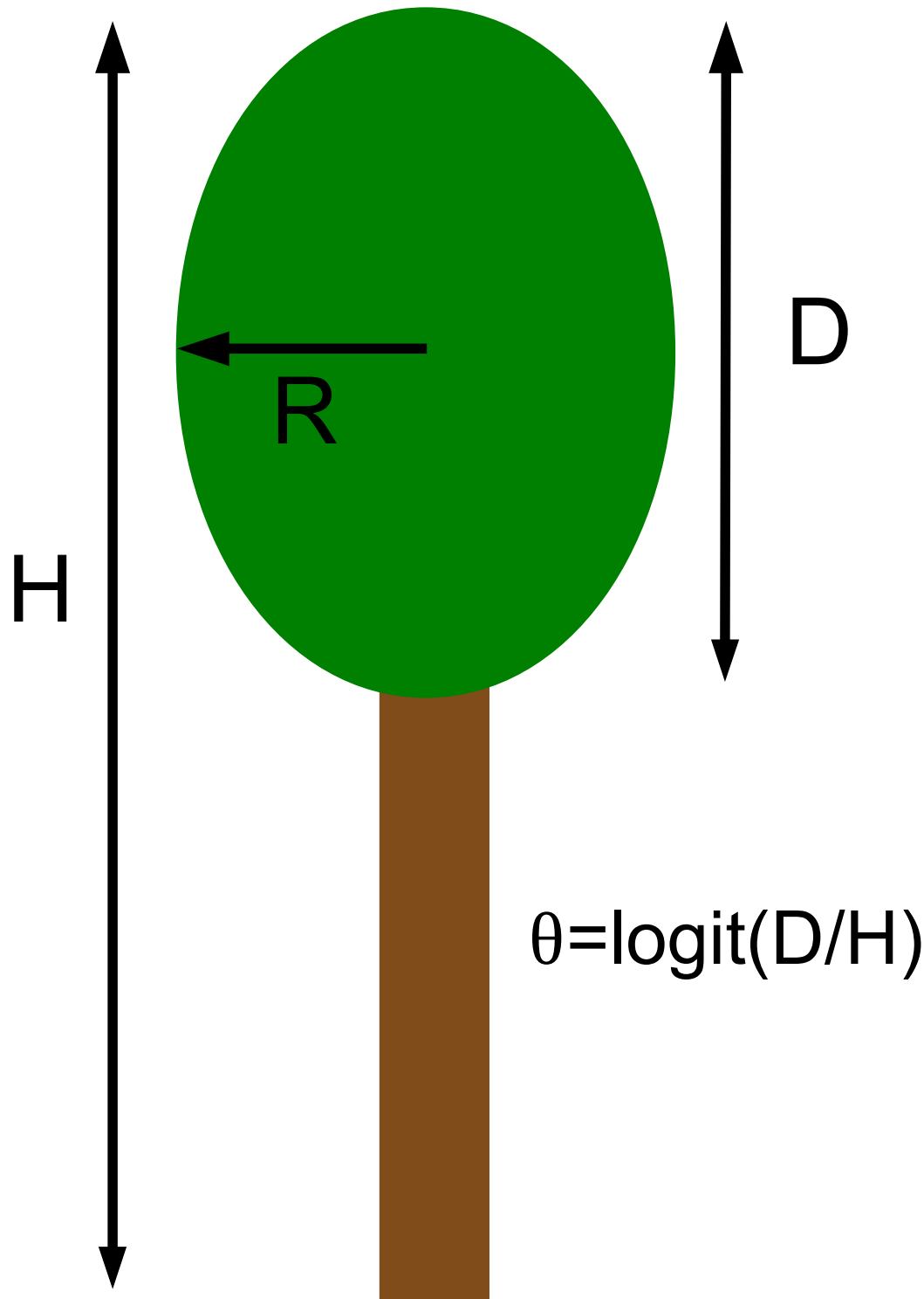

Canopy Radius

$$r_{i,j} \sim N(r_i^*, DBH \cdot \sigma_R^2)$$

- Tree crowns are rarely round
- Field data measured 2-8 separate crown radii per tree
- Rather than simply *average* these values a priori, treated \mathbf{R} as a latent variable similar to the errors in variables model
- Heteroskedastic
- Allowed partitioning of crown variability **within** individuals, **among** individuals within a species, and **across** species

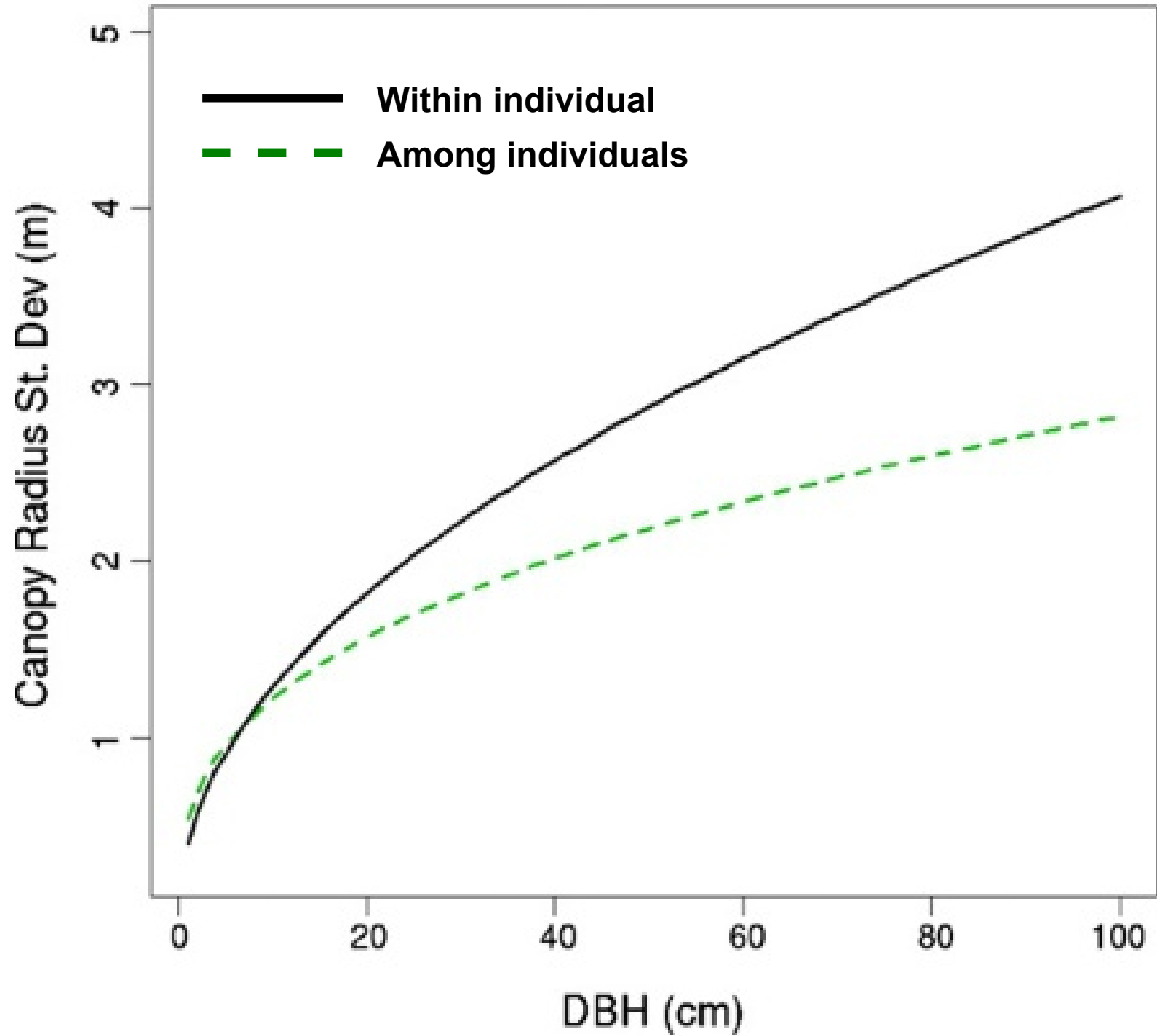

Red Oak

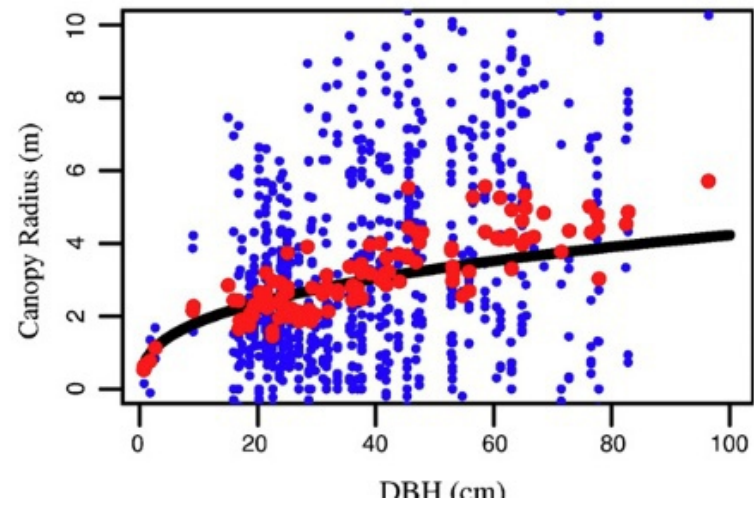
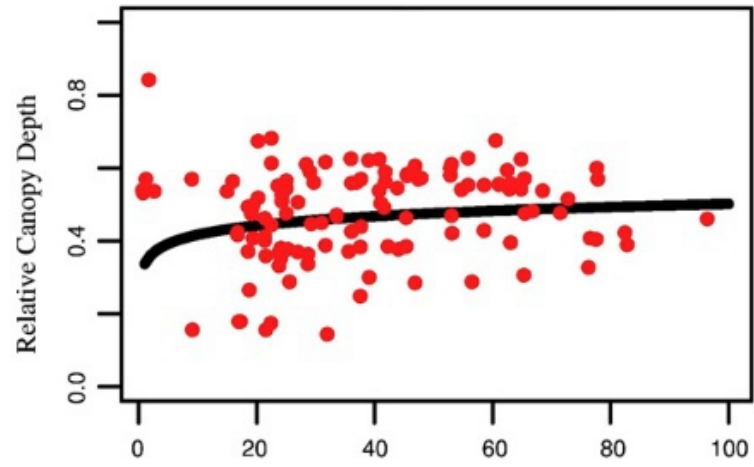
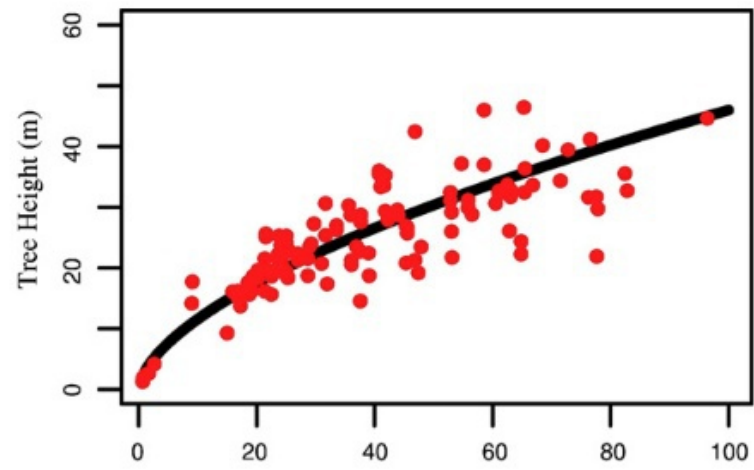

Hierarchical Covariates

- What factors affect the variability among species in their allometric relationships?

$$\beta_k \sim N_2(B, \tau^2 I)$$



$$\beta_k \sim N_2(ZB, \tau^2 I)$$

- Z = matrix of *across species* covariates
 - Shade tolerance, wood strength, angio/gymno

SHADE TOLERANCE

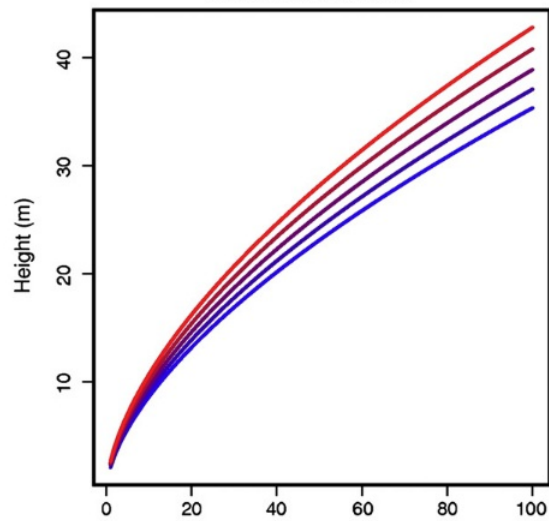

WOOD STRENGTH

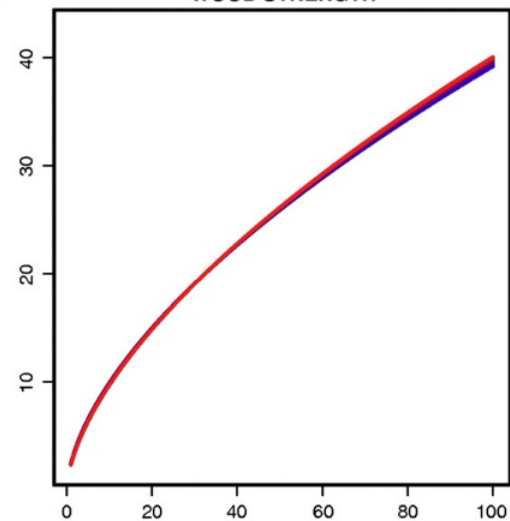

■ Tolerant
■ Intolerant

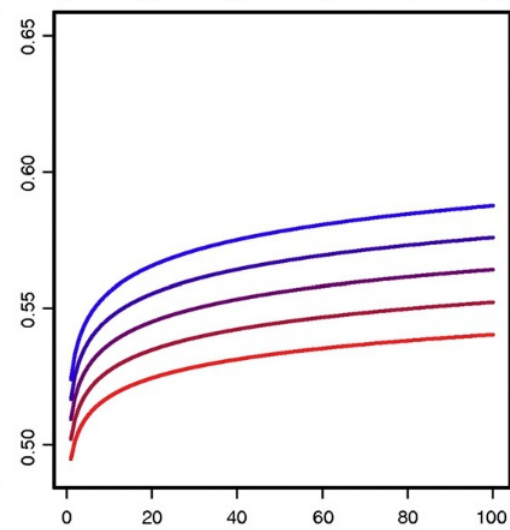
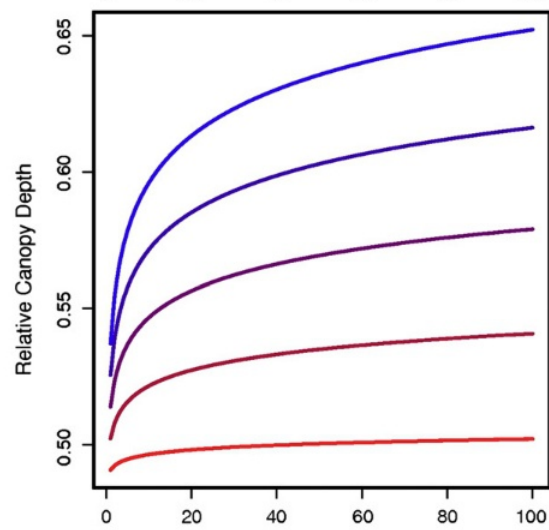

■ Weak
■ Strong

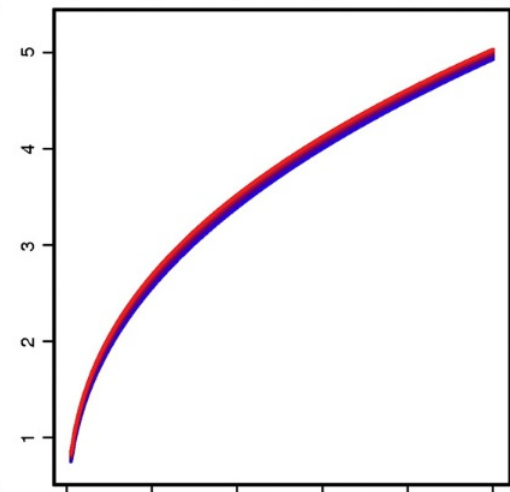
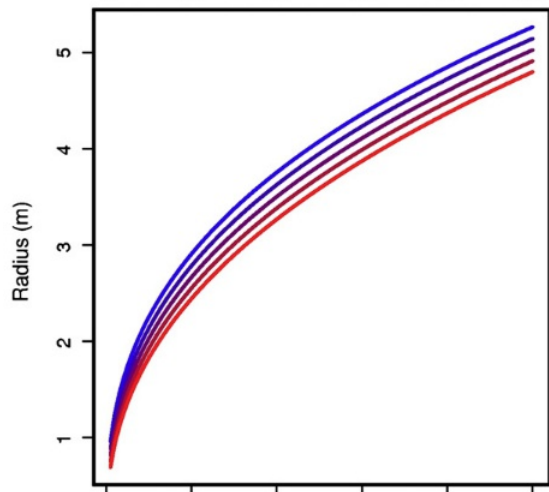

Prediction

- Hierarchical model structure would allow one to make predictions about an unobserved species
- Those predictions could be refined by knowing the hierarchical covariates
- Posterior for new species could be updated with a relatively small number of observations
- Structure could easily be extended to other forms of dependence (phylogenetic constraint, site covariates, etc.)

Summary

- Final Allometry model included
 - Multivariate Hierarchical linear model
 - Hierarchical covariates
 - Heteroskedasticity in radius
 - Latent variables/Errors in variables on radius
 - Borrowing strength / highly unbalanced data
 - Inference on rare species